

## VT230-IR







# VT230-IR

## EXTERNAL REAR-VIEW CAMERA

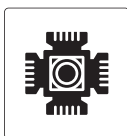
The **VT230-IR** is an external rear-view camera. With infrared LEDs and a sun shield, this camera is suitable for both day and night use and is compatible with VT2.2 forward-facing camera.

### Key features:

			
CMOS	Wide-viewing Angle	Easy Maintenance	IP69K

- ✓ 2.9 mm lens
- ✓ 120° wide-viewing angle
- ✓ 700TV lines
- ✓ IR night vision
- ✓ Wide sun shield
- ✓ Water-resistant (IP69K)
- ✓ 59.2(W) x 44.2(H) x 56(D)mm



**t** +44 (0) 1246 225 745  
**e** info@visiontrack.com  
**w** visiontrack.com  
**s** support.visiontrack.com

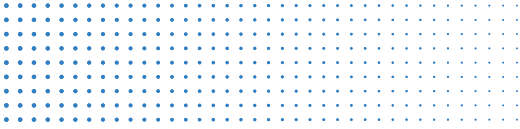

## VT230-IR

### Specifications:

Image Device	1/3" COLOR SHARP 960H CCD
H. Resolution	700TV lines
Min. Illumination	0.1 LUX
Lens	2.9mm (120°)
Night View Distance	10M
Power Supply	5V S-Jack Connection
Operating Temperature	-20°C ~ 60°C
IP	IP69K

### Dimensions:

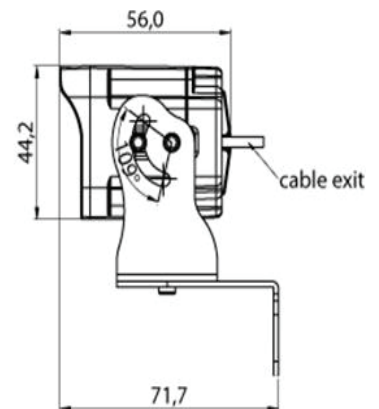
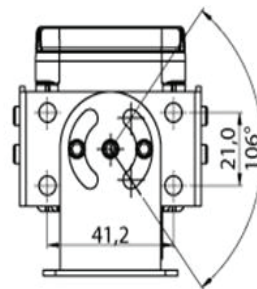
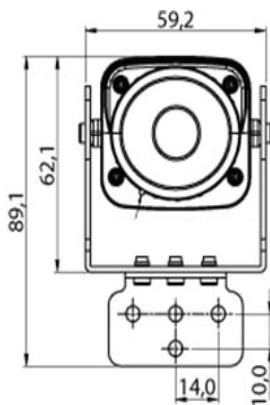

**t** +44 (0) 1246 225 745  
**e** info@visiontrack.com  
**w** visiontrack.com  
**s** support.visiontrack.com